



Jet Diffusers

Lynx Maxi Drum

At Gerhman we are driven by a strong desire to continuously generate improvements. We do that by developing products and systems that are easy to use and energy efficient, together with industry-leading knowledge, support, logistics and efficient availability.



gerhman.com

Jet Diffusers

Lynx Maxi Drum



Lynx Maxi Drum diffusers are designed to meet the needs of architectural applications demand and maintaining optimal air distribution performance over long distances. These jet diffusers boast fully adjustable, aerodynamic pattern controllers made from extruded aluminum.

Lynx Maxi Drum offers the perfect blend of engineering prowess and architectural allure.

Typical Applications

They can be mounted on the wall to diffuse the air horizontally in large spaces, or the ceiling to diffuse the air downward, for instance to cover high windowed walls.

Ideal for

- Shopping centers
- Airports
- Stations
- Sport halls
- Large spaces

Design

- Supply angle of $\pm 30^\circ$ the airflow can be adjusted both downwards and upwards
- Installation on wall to diffuse the air horizontally
- Installation on ceiling to diffuse the air downward
- For supply air to room air temperature differences from -12 to $+15$ K

Sizes

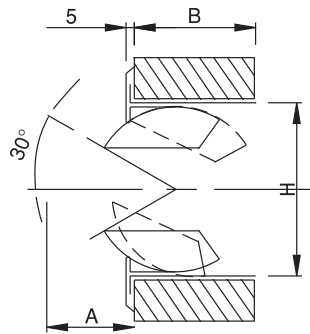
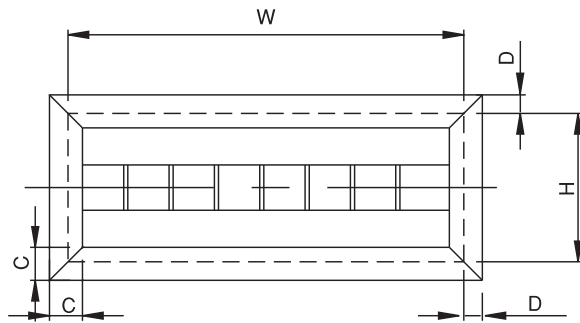

Lynx maxi drum

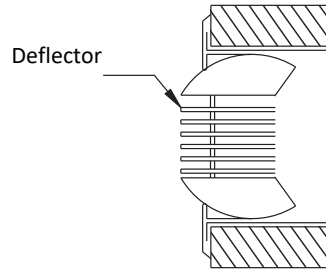

Lynx maxi drum +

Type		W	H	A	B	C	D
A	01	300	160	40	68	35	29
	02	375	160	40	68	35	29
	03	450	160	40	68	35	29
	04	600	160	40	68	35	29
	05	750	160	40	68	35	29
	06	900	160	40	68	35	29
B	07	600	258	70	105	35	29
	08	750	258	70	105	35	29
	09	900	258	70	105	35	29
	10	1050	258	70	105	35	29
	11	1200	258	70	105	35	29
	12	1350	258	70	105	35	29
	13	1500	258	70	105	35	29

Note: All sizes are in mm

Performance

1- Throw distance

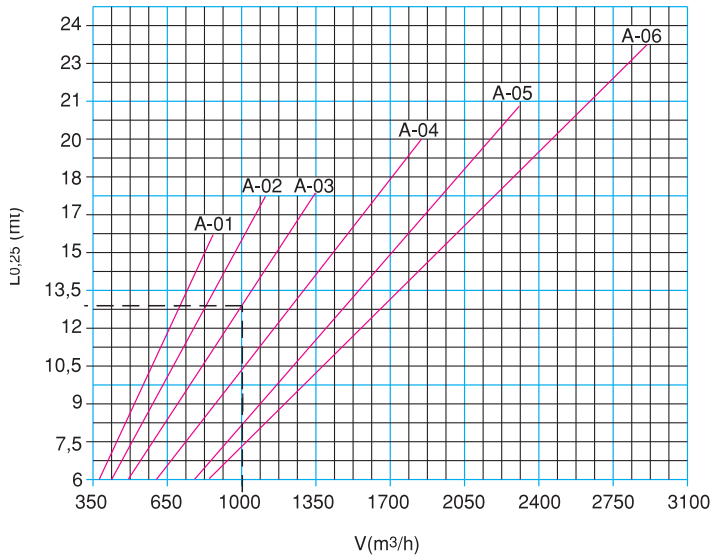

Type	Ak(m ²)
A-01	0,017
A-02	0,021
A-03	0,026
A-04	0,035
A-05	0,045
A-06	0,05

2- Pressure drop

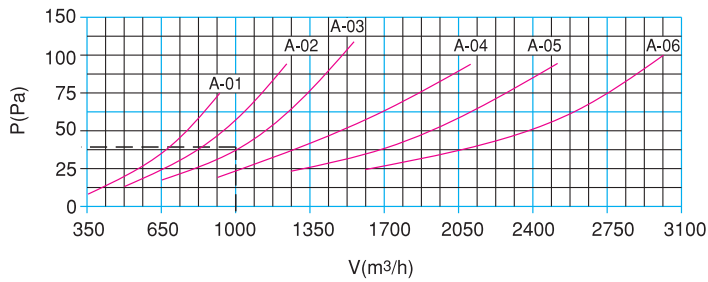

3- Noise level

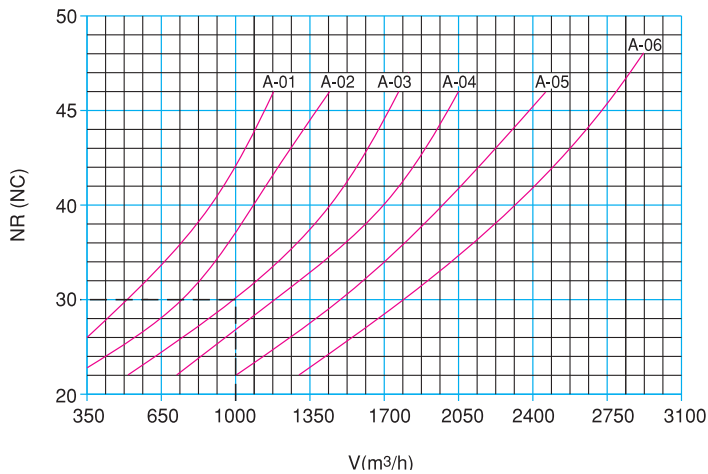

Performance

1- Throw distance

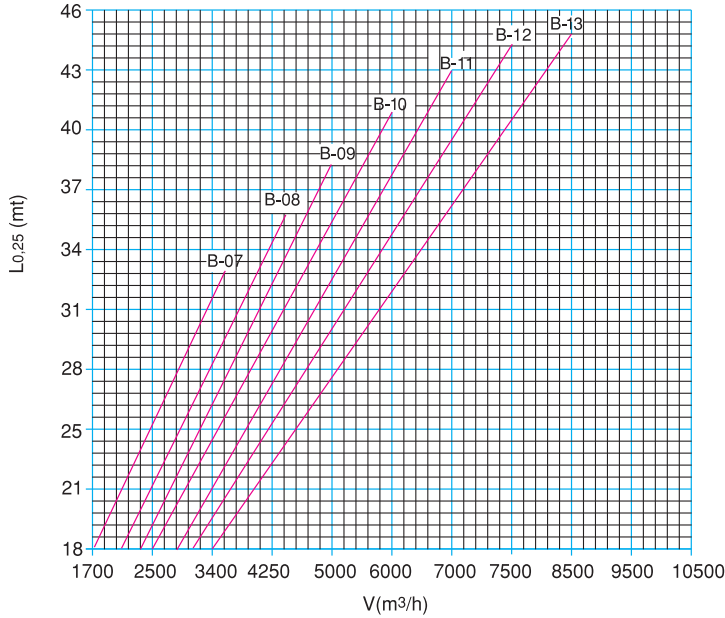

Type	Ak(m ²)
B-07	0,066
B-08	0,095
B-09	0,115
B-10	0,139
B-11	0,151
B-12	0,163
B-13	0,175

2- Pressure drop

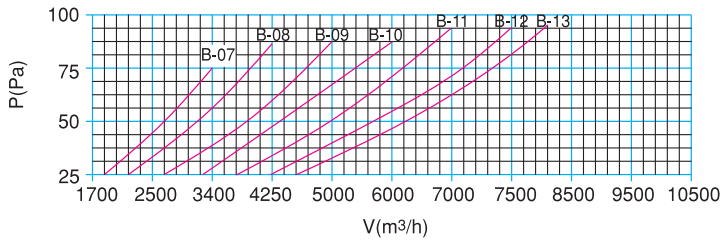

3- Noise level

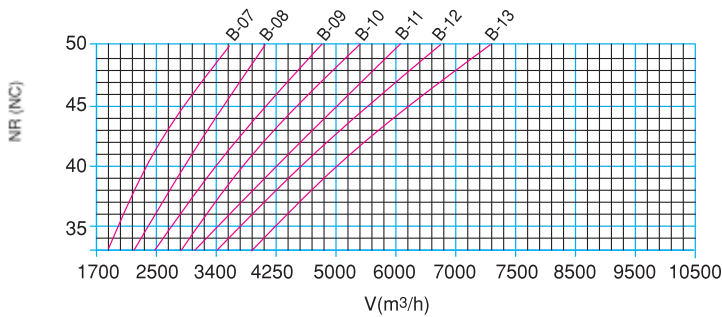





Jet Diffusers

Lynx Maxi Drum



• +90 0850 303 4766



• info@gerhman.com



• gerhman.com