



Long Throw Ceiling Diffuser

**Nova+**



At Gerhman we are driven by a strong desire to continuously generate improvements. We do that by developing products and systems that are easy to use and energy efficient, together with industry-leading knowledge, support, logistics and efficient availability.



[gerhman.com](https://gerhman.com)

## Long Throw Ceiling Diffuser

### Nova+

Diffuser is designed for room heights exceeding 3.8 m. It is suitable for large temperature requirements. It is suitable for large temperature difference between supply and room air. Diffuser is designed for mixed flow ventilation with different air patterns in heating and cooling modes with centrally adjustable blades. Blades can be manually adjustable or by the means of electric motor installed on the outer side of the diffuser. Diffuser is capable of altering discharge direction.



#### Specification

- For high rooms, with adjustable air control blades
- The air pattern can be adjusted manually or with an actuator
- Horizontal or vertical duct connection
- For supply air to room air temperature differences of  $-12$  to  $+15$  K
- For room heights exceeding 3.8 m
- Nominal sizes 315, 400, 630, 800
- For supply and exhaust air
- Variable and constant volume flows
- Volume flow rate range 250 – 4000 m<sup>3</sup>/h
- Maintenance-free

#### Specification

- Galvanised sheet steel diffuser
- Galvanised sheet steel plenum box
- Powder-coated, RAL 9010, pure white
- Powder-coated, RAL CLASSIC colour

#### Accessories

- Plenum box
- Servo Motor

## Technical sizes

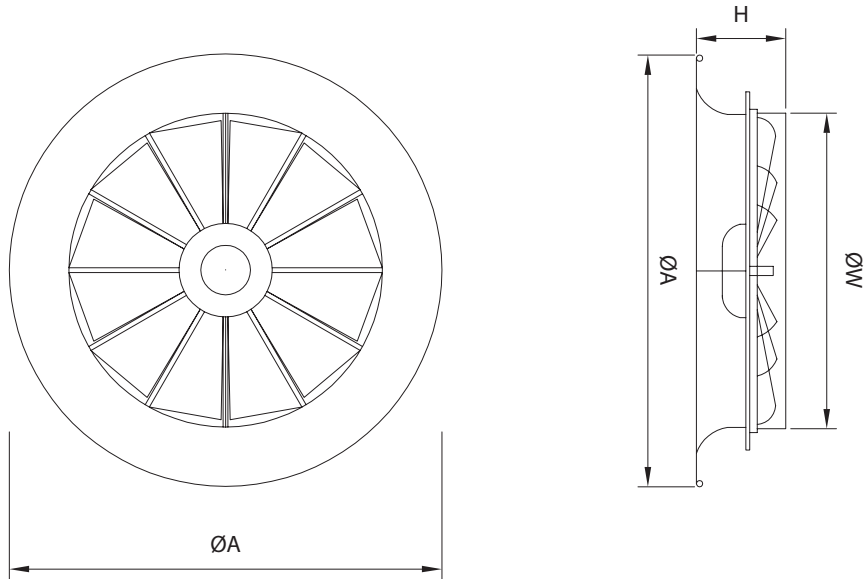

Size	315	400	500	630	800
<b>Aeff (m2)</b>	0.059	0.098	0.163	0.257	0.434
<b>ØW (mm)</b>	311	396	496	626	796
<b>ØA (mm)</b>	460	545	645	775	945
<b>H (mm)</b>	120	120	125	130	130

# Quick Selection

		$\Delta p_t$	$L_{WA}$
Nominal Size	m <sup>3</sup> /h	$P_a$	dB(A)
315	248	6	18
	424	18	32
	599	38	42
	775	64	49
400	345	5	14
	652	18	30
	959	39	39
	1270	68	48
630	852	6	15
	1471	17	31
	2100	35	41
	2728	56	48
800	1155	7	19
	1845	16	32
	2540	31	41
	3252	50	48

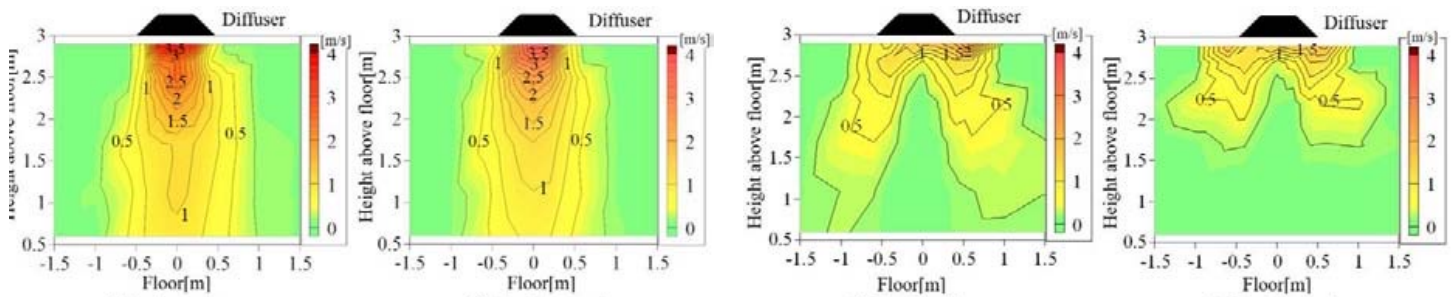

# Performance

## sound power level and total differential pressure

Nova+ 315

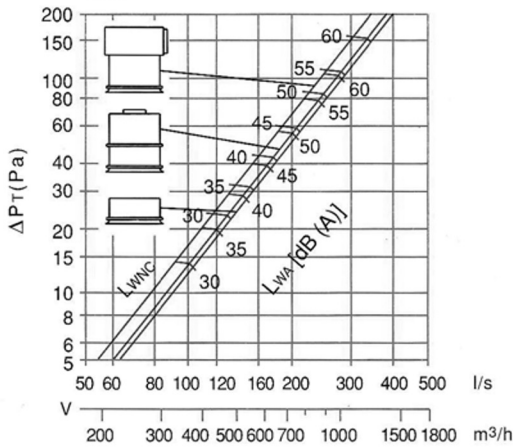

Nova+ 500

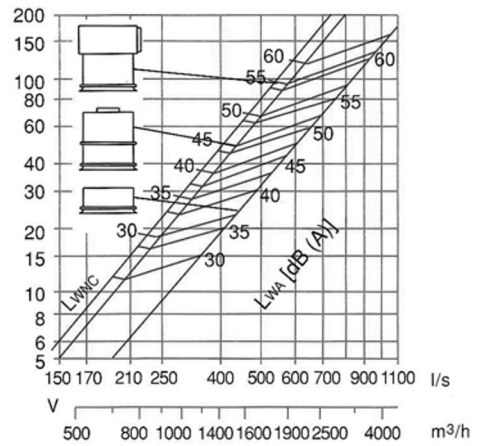

Nova+ 400

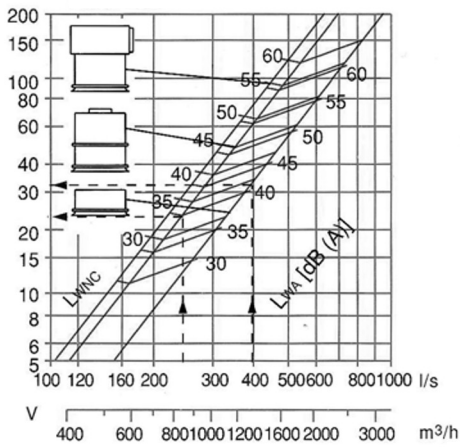

Nova+ 630

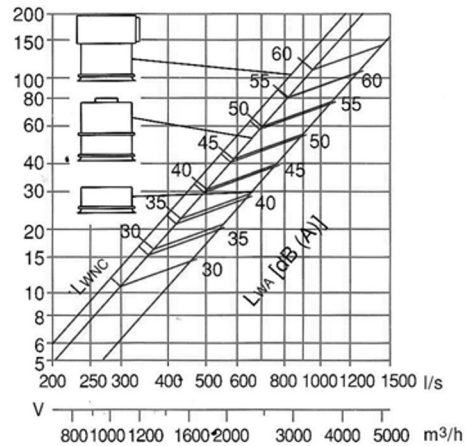

Nova+ 800

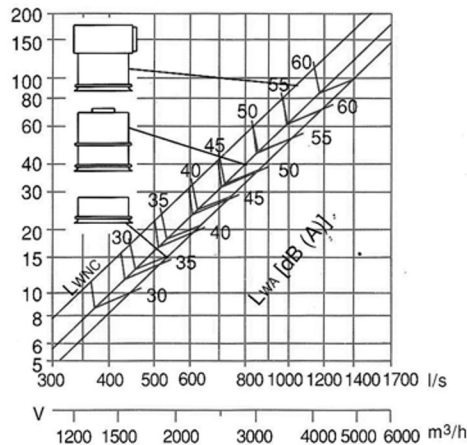

# Performance

## High induction results

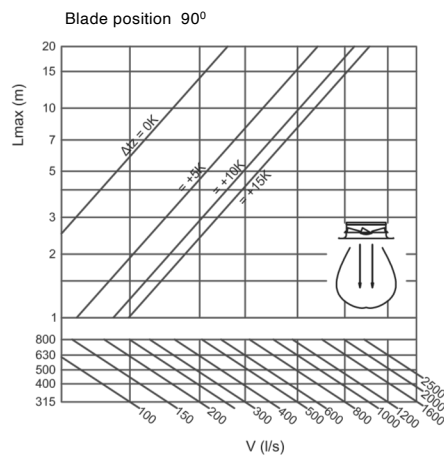
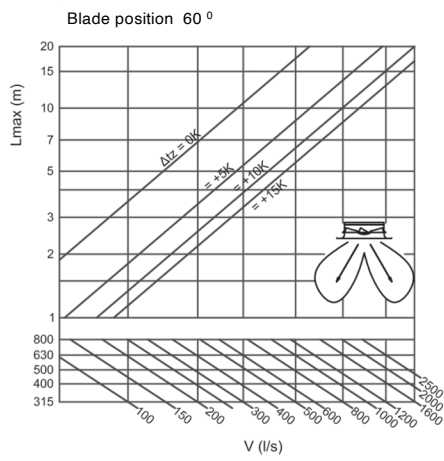
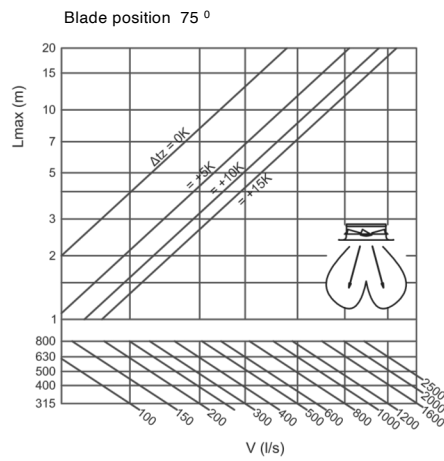
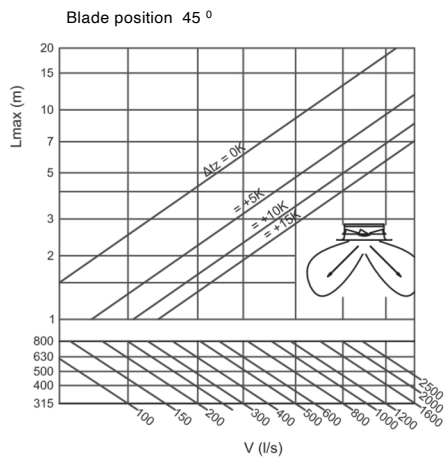

1 l/s = 3,6 m³/h

# Installation

## Installation with and without plenum box

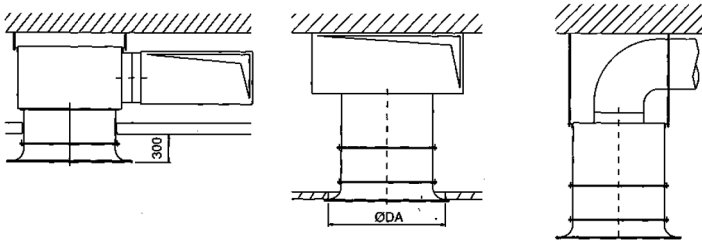
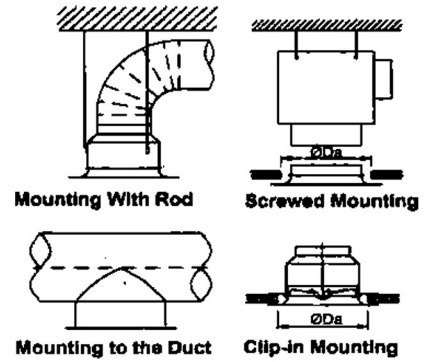
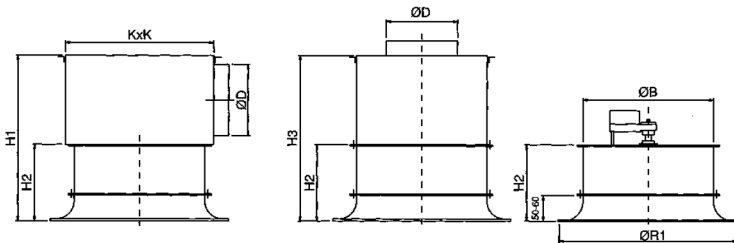

### Plenum Sizes

Size	B	D	H1	H2	H3	K	R1	ØDA
315	310	248	430	150	425	435	465	412
400	395	313	525	160	534	500	550	515
500	495	313	587	187	600	600	650	620
630	625	398	753	223	748	750	780	810
800	795	498	850	300	998	1000	950	1015



## Installation

Use only approved and adequately sized suspension systems (fixing material is not included in the supply package). Dimensions and weights are given in the technical leaflets.

To fix the diffuser to a vertical duct, you can use rivets or screws of  $\varnothing 4$  mm, set 25 mm below the connection opening at regular distances from each other. This requires that you suspend the duct such that it can take a sufficient load.

In order to protect the surface of the diffuser face, unpack and install it only after all other construction steps have been completed.

## Actuator Control



Order code	Supply voltage	Max. power rating	Control input signal
Nova+M1	85 – 265 V AC, 50/60 Hz	6 VA 2.5 W	i OPEN/ CLOSE i (3-point)
Nova+M2	24 V AC $\pm 20\%$ , 50/60 Hz 24 V DC $\pm 20\%$	4 VA 1.5 W	i OPEN/ CLOSE i (3-point)
Nova+M3	24 V AC $\pm 20\%$ , 50/60 Hz 24 V DC $\pm 20\%$	4 VA 2W	2 – 10 V DC, Ra > 100 k $\Omega$



gerhman.com

## Long Throw Ceiling Diffuser

### Nova+



+90 0850 303 4766



info@gerhman.com



gerhman.com